

SENCO®

SFW10XP

Operating Instructions
Instrucciones de Operacion
Mode d'Emploi



*Senco Products Inc.
8485 Broadwell Road
Cincinnati, Ohio 45244*



*Questions? Comments?
call SENCOS toll-free Action-line: 1-800-543-4596
or e-mail: toolprof@senco.com www.senco.com*



Warnings for the safe use of this tool are included in this manual.
Los avisos para el uso seguro de esta herramienta están incluidos
en este manual.
Les consignes pour l'utilisation en toute sécurité de cet outil se
trouvent dans ce manuel.

© 2007 by Senco Products, Inc.

NFD81D Issued January 8, 2007

English	Español	Français
---------	---------	----------

TABLE OF CONTENTS	TABLA DE MATERIAS	TABLE DES MATIÈRES		
Tool Use	2	Utilisation de l'outil	2	
Accessories	5	Accesorios	5	
Maintenance	6	Mantenimiento	6	
Troubleshooting	7	Identificación	Dépannage	7
Specifications	8	de Fallas	Spécifications	8
	Especificaciones		8	

EMPLOYER'S RESPONSIBILITIES	RESPONSABILIDADES DEL EMPLEADOR	RESPONSABILITÉS DE L'EMPLOYEUR
Employer must enforce compliance with the safety warnings and all other instructions which accompany this tool as shipped from the manufacturer.	El empleador debe hacer cumplir las advertencias de seguridad y todas las otras instrucciones que acompañan a esta herramienta como se la despacha desde el fabricante.	L'employeur doit faire appliquer les consignes de sécurité et toutes les autres instructions qui accompagnent cet outil tel qu'il est livré par son constructeur.
Keep this manual available for use by all people assigned to the use of this tool.	Mantenga este manual disponible para que lo usen todas las personas destinadas a hacer uso de esta herramienta.	Ayez ce manuel à la disposition de toutes les personnes chargées d'utiliser cet outil.
For personal safety and proper operation of this tool, read and understand all of these instructions carefully.	Por razones de seguridad personal y la adecuada operación de esta herramienta, lea y comprenda todas estas instrucciones cuidadosamente.	Pour assurer la sécurité personnelle et le bon emploi de cet outil, lisez et assimilez soigneusement toutes ces instructions.

Tool Use	Uso de la Herramienta	Utilisation de l'Outil
<ul style="list-style-type: none"> Read and understand "SAFETY INSTRUCTIONS" manual shipped with this tool before using tool. 	<ul style="list-style-type: none"> Antes de usar la herramienta lea y comprenda el manual "INSTRUCCIONES DE SEGURIDAD" despachado con ella. 	<ul style="list-style-type: none"> Lisez et assimilez le manuel "INSTRUCTIONS DE SÉCURITÉ" livré avec cet outil avant de l'utiliser.

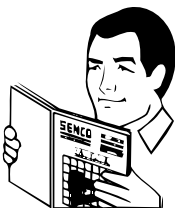

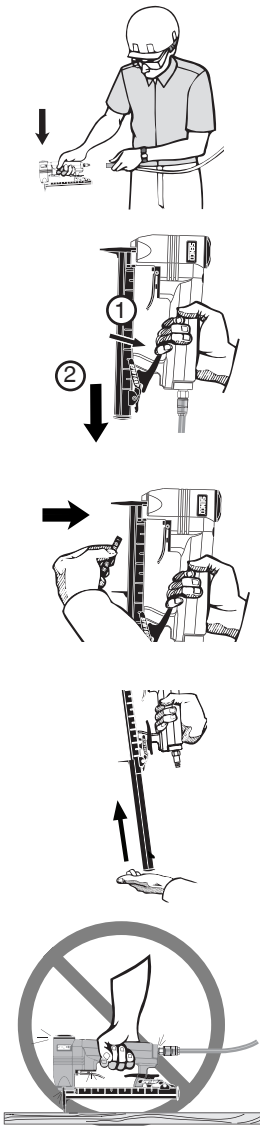

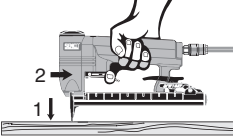
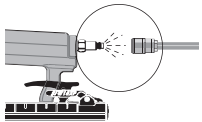
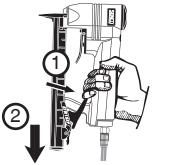
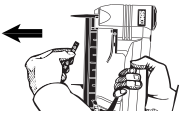
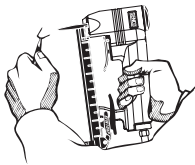
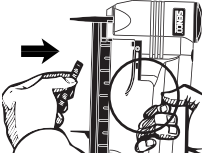
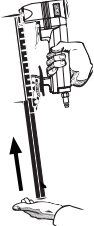

Tool Use Uso de la Herramienta Utilisation de l'Outil		
English	Español	Français
<ul style="list-style-type: none"> ● Keep tool pointed away from yourself and others and connect air to tool. 	<ul style="list-style-type: none"> ● Mantenga la herramienta apuntando en la dirección opuesta de usted y de otros y conecte el aire a la manguera. 	<ul style="list-style-type: none"> ● Maintenez l'outil pointé à l'écart d'autres personnes et de vous-même et raccordez l'air à l'outil.
<ul style="list-style-type: none"> ● To Load: Depress latch and slide rail open. 	<ul style="list-style-type: none"> ● Para cargar: Oprima el cerrojo y deslice el carril abriéndolo. 	<ul style="list-style-type: none"> ● Pour charger : Appuyer sur le verrou et ouvrir le rail en le tirant.
<ul style="list-style-type: none"> ● Lay strip of staples into magazine. Use only genuine SENCO staples. Do not load with trigger depressed. 	<ul style="list-style-type: none"> ● Coloque la tira de grapas dentro del cargador. Use solamente sujetadores SENCO auténticos. No cargue con el gatillo oprimidos. 	<ul style="list-style-type: none"> ● Insérer la bande d'agrafes dans le magasin. Utilisez uniquement les véritables agrafes SENCO. Veillez à ne pas appuyer sur la détente quand vous chargez.
<ul style="list-style-type: none"> ● Push rail forward until it latches. 	<ul style="list-style-type: none"> ● Empuje el carril hacia adelante hasta cerrarlo. 	<ul style="list-style-type: none"> ● Pousser le rail jusqu'à encliquetage.
<ul style="list-style-type: none"> ● Never use a tool that leaks air or needs repair. 	<ul style="list-style-type: none"> ● Nunca use una herramienta que tenga escapes de aire o que necesite reparación. 	<ul style="list-style-type: none"> ● N'utilisez jamais un outil qui a des fuites d'air ou qui a besoin d'être réparé.

Tool Use	Uso de la Herramienta	Utilisation de l'Outil
English	Español	Français
 <ul style="list-style-type: none"> ● To drive fasteners: Position tool against work surface and pull the trigger. ● These tools are not required to have a workpiece contact. USE CAUTION as these tools will drive a fastener when the trigger is pulled. 	<ul style="list-style-type: none"> ● Para clavar las grapas: Coloque la herramienta contra la superficie de trabajo y apretar el gatillo. ● Para estas herramientas no se necesita un punto de contacto con la pieza de trabajo. SEA PRECAVIDO ya que estas herramientas dispararán una grapa cuando se aprieta el gatillo. 	<ul style="list-style-type: none"> ● Pouragrafer : Position l'appareil contre la surface de travail et presser sur la gâchette. ● Ces outils ne nécessitent pas de contact avec la pièce. FAIRE ATTENTION car ils enfonceront une agrafe dès que la gâchette est actionnée.
 <ul style="list-style-type: none"> ● Should a staple jam occur, disconnect air supply. 	<ul style="list-style-type: none"> ● Si se produce un atascamiento de las grapas, desconecte el suministro de aire. 	<ul style="list-style-type: none"> ● Si un enrayage se produit, coupez l'arrivée d'air.
 <ul style="list-style-type: none"> ● 1) Depress latch and 2) slide rail open. 	<ul style="list-style-type: none"> ● 1) Oprima el cerrojo y 2) deslice el carril abriéndolo. 	<ul style="list-style-type: none"> ● 1) Appuyer sur le verrou et 2) ouvrir le rail en le tirant.
 <ul style="list-style-type: none"> ● Remove staples. 	<ul style="list-style-type: none"> ● Saque las grapas. 	<ul style="list-style-type: none"> ● Enlever les agrafes.
 <ul style="list-style-type: none"> ● Remove jammed fastener. 	<ul style="list-style-type: none"> ● Remueva el sujetador atascado. 	<ul style="list-style-type: none"> ● Enlevez le projectile coincé.
 <ul style="list-style-type: none"> ● Lay strip of staples onto rail. Use only genuine SENCO fasteners (see Parts Chart). Do not load with trigger depressed. 	<ul style="list-style-type: none"> ● Coloque una tira de grapas en el riel. Use solamente grapas SENCO genuinas (ver la Tabla de Partes). No cargue la herramienta con el gatillo oprimido. 	<ul style="list-style-type: none"> ● Mettez une série d'agrafes dans le chargeur. N'utilisez que de véritable agrafes SENCO (voir Tableau des Pièces). N'appuyez pas sur la détente pendant le rechargement.
 <ul style="list-style-type: none"> ● Release staple door and slide it forward. 	<ul style="list-style-type: none"> ● Destrahe la compuerta de las grapas y deslícela hacia adelante. 	<ul style="list-style-type: none"> ● Relâcher le pousse agrafes et le faire glisser vers l'avant.

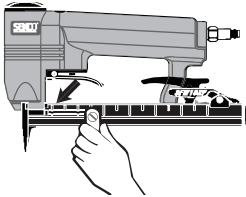
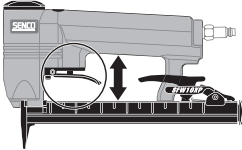
Accessories	Accesorios	Accessoires
English	Español	Français
<p>SENCO offers a full line of accessories for your SENCO tools, including:</p> <ul style="list-style-type: none"> ● Air Compressors ● Hose ● Couplers ● Fittings ● Safety Glasses ● Pressure Gauges ● Lubricants ● Regulators ● Filters <p>For more information or a complete illustrated catalogue of SENCO accessories, ask your representative for #MK336.</p>	<p>SENCO ofrece una línea completa de Accesorios para sus herramientas SENCO, incluyendo:</p> <ul style="list-style-type: none"> ● Compresores de Aire ● Manguera ● Conectores Rápidos ● Conectores ● Anteojos De Seguridad ● Manómetros ● Lubricantes ● Reguladores ● Filtros <p>Para mas informacion ó un pour recevoir un catalogo completo ilustrado de los Accesorios SENCO, pregunte a su representante pour el numero MK336.</p>	<p>SENCO offre une gamme étendue d'accessoires pour vos outils SENCO y compris :</p> <ul style="list-style-type: none"> ● Compresseurs ● Tuyauterie flexible ● Raccords ● Lunettes de sécurité ● Manomètres ● Lubrifiants ● Régulateurs ● Filtres <p>Pour plus d'informations ou pour recevoir un catalogue détaillé des accessoires proposés par SENCO, prenez contact avec votre représentant SENCO (référence catalogue : #MK336).</p>

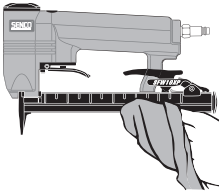
Maintenance	Mantenimiento	Entretien
English	Español	Français
 <ul style="list-style-type: none"> ● Read and understand "SAFETY INSTRUCTIONS" manual shipped with this tool before using tool. 	<ul style="list-style-type: none"> ● Antes de usar la herramienta lea y comprenda el manual "INSTRUCCIONES DE SEGURIDAD" despachado con ella. 	<ul style="list-style-type: none"> ● Lisez et assimilez le manuel "INSTRUCTIONS DE SÉCURITÉ" livré avec cet outil avant de l'utiliser.
 <ul style="list-style-type: none"> ● All screws should be kept tight. Loose screws result in unsafe operation and parts breakage. 	<ul style="list-style-type: none"> ● Todos los tornillos tienen que mantenerse apretados. Los tornillos sueltos pueden producir una operación no segura y quebraduras de partes. 	<ul style="list-style-type: none"> ● Toutes les vis doivent être maintenues serrées à fond. Les vis desserrées entraînent un manque de sûreté du fonctionnement et la rupture de pièces.
 <ul style="list-style-type: none"> ● With tool disconnected, make daily inspection to assure free movement of trigger. Do not use tool if trigger sticks or binds. 	<ul style="list-style-type: none"> ● Con la herramienta desconectada, haga inspecciones diarias para asegurar un movimiento libre del disparador. No use la herramienta si el disparador se pegan o se atascan. 	<ul style="list-style-type: none"> ● L'outil étant déconnecté de l'arrivée d'air comprimé, effectuez une inspection journalière pour vous assurer le libre mouvement de la détente. N'utilisez pas l'outil si la détente colle ou se coince.
 <ul style="list-style-type: none"> ● Squirt SENCO pneumatic oil (5 to 10 drops) into the air inlet twice daily (depending on frequency of tool use). Other oils may damage O-rings and other tool parts. 	<ul style="list-style-type: none"> ● Aplique aceite neumático SENCO en la entrada de aire dos veces al día (dependiendo en la frecuencia de uso 5 A 10 Gotas). Otros aceites pueden dañar los anillos en "O" y otras piezas de la herramienta. 	<ul style="list-style-type: none"> ● Avec une burette, placer 5 à 10 gouttes d'huile pneumatique dans l'arrivée d'air deux fois par jour (dépend de l'intensité de l'utilisation de l'appareil). D'autres huiles pourraient endommager les joints toriques et d'autres pièces de l'outil.
 <ul style="list-style-type: none"> ● Wipe tool clean daily and inspect for wear. Use non-flammable cleaning solutions only if necessary—DO NOT SOAK. Caution: Such solutions may damage O-rings and other tool parts. 	<ul style="list-style-type: none"> ● Use soluciones de limpieza no inflamables solamente si es necesario—NO LA REMOJE. Precaución: Tales soluciones pueden dañar los empaques y otras partes de la herramienta. 	<ul style="list-style-type: none"> ● Nettoyez l'outil chaque jour à l'aide d'un chiffon et inspectez-le pour déceler une éventuelle usure. Utilisez uniquement des solvants non inflammables en cas de nécessité—NE LE FAITES PAS TREMPER ! Attention : De tels produits peuvent endommager les joints et autres pièces de l'appareil.

Troubleshooting**Identificación de Fallas****Dépannage****English****Español****Français****WARNING**

Repairs other than those described here should be performed only by trained, qualified personnel. Contact SENCO for information at 1-800-543-4596.

- Read and understand "SAFETY INSTRUCTIONS" manual shipped with this tool before using tool.

ALERTA

Las reparaciones, fuera de aquellas descritas aquí, deben de ser llevadas a cabo solamente por personal entrenado y calificado. Póngase en contacto con SENCO para información 1-800-543-4596.

- Antes de usar la herramienta lea y comprenda el manual "INSTRUCCIONES DE SEGURIDAD" despachado con ella.

AVERTISSEMENT

Les réparations autres que celles décrites ici doivent être réalisées uniquement par du personnel qualifié ayant reçu la formation appropriée. Pour toute information, prenez contact avec SENCO par téléphone en appelant Le Distributeur agréé.

- Lisez et assimilez le manuel "INSTRUCCIONES DE SÉCURITÉ" livré avec cet outil avant de l'utiliser.

SYMPTOM

Air leak near top of tool / Sluggish operation

SOLUTION

Verify air supply / tighten screws or install Firing System Kit A (YK0322).

SÍNTOMA

El aire se escapa cerca de la parte superior de la herramienta / Operación lenta.

SOLUCIÓN

Apriete los tornillos / Verifique el suministro de aire o instale el Juego de Partes A (YK0322).

SYMPTÔME

Fuite d'air près du sommet de l'outil / fonctionnement lent.

SOLUTION

Serrez les vis à fond / vérifiez l'alimentation en air ou remplacez les pièces portant la lettre "A" (YK0322).

SYMPTOM

Air leak near bottom of tool / Poor return.

SOLUTION

Clean tool / tighten screws or install Piston Stop Kit B (YK0321).

SÍNTOMA

El aire se fuga cerca de la parte inferior de la herramienta / Mal retorno.

SOLUCIÓN

Apriete los tornillos / Limpié la herramienta o instale el Juego de Partes B (YK0321).

SYMPTÔME

Fuite d'air près de la base de l'outil / retour inadéquat.

SOLUTION

Serrez les vis à fond / nettoyez l'outil ou remplacez les pièces portant la lettre "B" (YK0321).

SYMPTOM

Other problems.

SOLUTION

Contact SENCO.

SÍNTOMA

Otros problemas.

SOLUCIÓN

Póngase en contacto con SENCO.

SYMPTÔME

Autres problèmes.

SOLUTION

Prenez contact avec SENCO.

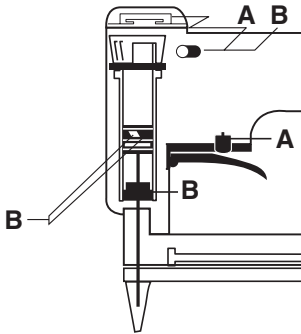

English TECHNICAL SPECIFICATIONS		
Minimum to maximum operating pressure	60–95 psi	4,1–6,5 bar
Air Consumption (60 cycles per minute)	.77 scfm	21,8 liter
Air Inlet	1/4 in. NPT	1/4 in. NPT
Maximum Speed (cycles per minute)	15 (Sencomatic)	15 (Sencomatic)
Weight	2.0 lbs.	0,9 kg
Staple Capacity	110-185	110-185
Tool size: Height	5 15/16 in.	151 mm
Tool size: Length	9 1/2 in.	241 mm
Tool size: Width: Main Body	1 15/16 in.	49 mm

Español ESPECIFICACIONES TÉCNICAS		
Presión de operación mínima y máxima	4,1–6,5 bar	60–95 psi
Consumo de aire (60 ciclos por minuto)	21,8 liter	.77 scfm
Entrada de aire	1/4 in. NPT	1/4 in. NPT
Velocidad máxima (ciclos por segundo)	15 (Sencomatic)	15 (Sencomatic)
Peso	0,9 kg	2.0 lbs.
Capacidad de grapas por cargador	110-185	110-185
Tamaño de la herramienta: Altura	151 mm	5 15/16 in.
Tamaño de la herramienta: Longitud	241 mm	9 1/2 in.
Tamaño de la herramienta: Ancho (Cuerpo)	49 mm	1 15/16 in.

Français SPECIFICATIONS TECHNIQUES		
Pression de travail min. et max.	4,1–6,5 bar	60–95 psi
Consommation d'air (60 cycles par minute)	21,8 liter	.77 scfm
Admission d'air	1/4 in. NPT	1/4 in. NPT
Vitesse maximum (cycles par seconde)	15 (Sencomatic)	15 (Sencomatic)
Poids	0,9 kg	2.0 lbs.
Capacité de projectiles par magasin	110-185	110-185
Dimensions de l'outil: hauteur	151 mm	5 15/16 in.
Dimensions de l'outil: longueur	241 mm	9 1/2 in.
Dimensions de l'outil: largeur: corps de	49 mm	1 15/16 in.

Specifications

Especificaciones

Specifications

English

Español

Français

Tool: 1D0001N

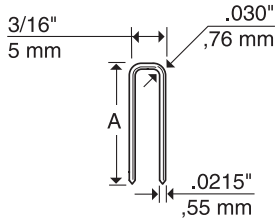

Code	A	
	inches	mm
A06	3/8	10
A08	1/2	13
D10	5/8	16

Tool: 1D0041N

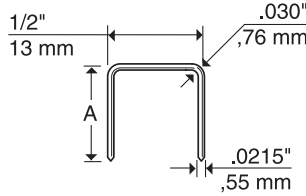

Code	A	
	inches	mm
B06	3/8	10
B08	1/2	13

Tool: 1D0061N

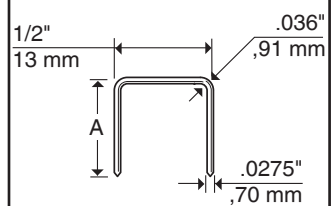

Code	A	
	inches	mm
AT04	1/4	6
AT05	5/16	8
AT06	3/8	10
AT08	15/32	12
AT09	9/16	14
AT10	5/8	16

Tool: 1D0021N

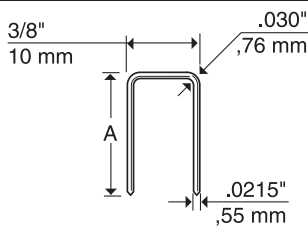

Code	A	
	inches	mm
C06	3/8	10
C07	7/16	11
C08	1/2	13
C10	5/8	16

Tool: 1D0001N

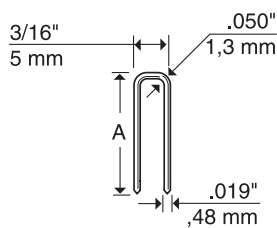

Code	A	
	inches	mm
E06	3/8	10
E07	7/16	11
E08	1/2	13
E10	5/8	16

Tool: 1D0051N

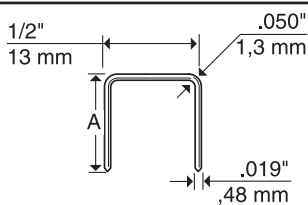

Code	A	
	inches	mm
F06	3/8	10
F08	1/2	13

Tool: 1D0031N

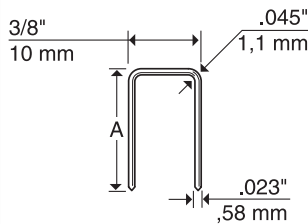

Code	A	
	inches	mm
G06	3/8	10
G08	1/2	13
G10	5/8	16

Limited Warranty SENCO® Pneumatic, DuraSpin®, Cordless Tools & Compressors

Senco Products, Inc. ("SENCO") designs and constructs its products using the highest standards of material and workmanship. SENCO warrants to the original retail purchaser that the following products will be free from defects in material or workmanship for the warranty period specified below:

SENCO® XP Series Five years	SENCO PRO Series One year	SENCO Compressors One year
SENCO DuraSpin® One year	SENCO Cordless Two years	SENCO Reconditioned Products One Year

During the warranty period (which begins on the purchase date), SENCO will repair or replace, at SENCO's option and expense, any product or part that is defective in materials or workmanship after examination by a SENCO Authorized Warranty Service Center, subject to the exceptions, exclusions and limitations described below. Any replacement product or part will carry a warranty for the balance of the warranty period applicable to the replaced product or part. A DATED SALES RECEIPT OR PROOF OF PURCHASE FROM THE ORIGINAL RETAIL PURCHASER IS REQUIRED TO MAKE A WARRANTY CLAIM. Warranty registration also is required and can be accomplished through on-line Product Registration at www.senco.com or by completing and returning the postage paid warranty registration form included with your Operator's manual/parts chart information, found inside the product carton. To make a warranty claim, you must return the product, with proper receipt/proof of purchase and return transportation charges prepaid, to a SENCO Authorized Warranty Service Center. A list of SENCO Authorized Warranty Service Centers can be found at www.senco.com or by calling 1-800-543-4596 toll free. SENCO will perform its obligations under this warranty, within a reasonable time after approval of the warranty claim.

Wheelbarrow Compressors:

- Subject to the exceptions, exclusions and limitations described below, SENCO warrants that the compressor pump will be free from defects in materials and workmanship for two years after the purchase date.
- Defective parts of the compressor pump not subject to normal wear and tear will be repaired or replaced, at SENCO's option, during the two year warranty period. If SENCO determines that repair or replacement is not feasible, SENCO will refund the purchase price less reasonable depreciation based on actual use.

SENCO Cordless:

- Subject to the exceptions, exclusions and limitations described below, SENCO warrants that the SENCO Cordless tool will be free from defects in materials and workmanship for two years after the purchase date.
- SENCO warrants that the batteries and chargers used with SENCO Cordless tools will be free from defects in material and workmanship for one year after the purchase date.

WARRANTY EXCLUSIONS

The following warranty exclusions apply:

- Normal wear parts are not covered under this warranty. Normal wear parts include, for example, isolators, drive belts, air filters, rubber o-rings, seals, driver blades, piston stops, and piston/driver assembly.
- This warranty does not cover parts damaged due to normal wear, misapplication, misuse, accidents, operation at other than recommended speeds or voltage (electric units only), improper storage, or damage resulting during shipping.
- Products used in production/industrial applications as defined by SENCO are excluded from this warranty.
- Labor charges or loss or damage resulting from improper operation, maintenance or repairs are not covered by this warranty.
- SENCO does not warrant the Wheelbarrow Compressor Engine/Motor, but the Compressor Engine/Motor may be covered under a warranty offered by its manufacturer.

GENERAL WARRANTY CONDITIONS

This warranty will be honored, only if:

- Clean, dry, regulated compressed air has been used, at air pressure not exceeding the maximum indicated on the tool casting;
- No evidence of abuse, abnormal conditions, accident, neglect, misuse or improper modifications or storage of the product; and
- No Deviation from operating instructions, specifications, and maintenance schedules exists (read Operator Manual for use, specifications, and maintenance instructions).

THIS WARRANTY IS THE ONLY WARRANTY ON THE PRODUCT, AND SENCO DISCLAIMS ALL OTHER WARRANTIES. ANY IMPLIED WARRANTIES WILL BE LIMITED IN DURATION TO THE APPLICABLE WARRANTY PERIOD SPECIFIED ABOVE. SOME STATES DO NOT ALLOW LIMITATIONS ON HOW LONG AN IMPLIED WARRANTY LASTS. SO THE ABOVE LIMITATION MAY NOT APPLY TO YOU. YOUR REMEDIES ARE SOLELY AND EXCLUSIVELY AS STATED ABOVE. SENCO SHALL IN NO EVENT BE LIABLE FOR INCIDENTAL, CONSEQUENTIAL, INDIRECT, OR SPECIAL DAMAGES. SOME STATES DO NOT ALLOW THE EXCLUSION OR LIMITATION OF INCIDENTAL OR CONSEQUENTIAL DAMAGES, SO THE ABOVE LIMITATION OR EXCLUSION MAY NOT APPLY TO YOU. IN NO EVENT, WHETHER AS A RESULT OF A BREACH OF CONTRACT, WARRANTY, TORT (INCLUDING NEGLIGENCE) OR OTHERWISE, SHALL SENCO'S LIABILITY EXCEED THE PRICE OF THE PRODUCT WHICH HAS GIVEN RISE TO THE CLAIM OR LIABILITY. ANY LIABILITY CONNECTED WITH THE USE OF THIS PRODUCT SHALL TERMINATE UPON THE EXPIRATION OF THE WARRANTY PERIOD SPECIFIED ABOVE. NO EMPLOYEE OR REPRESENTATIVE OF SENCO OR ANY DISTRIBUTOR OR DEALER IS AUTHORIZED TO MAKE ANY CHANGE OR MODIFICATION TO THIS WARRANTY.

This warranty gives you specific legal rights, and you may also have other rights which vary from state to state.

REPLACEMENT OF TOOL DUE TO NATURAL DISASTER

SENCO will replace any tool destroyed by an Act of God such as flood, earthquake, hurricane or other disaster resulting only from the forces of nature. Such a claim will be honored provided that such original retail purchaser had previously submitted a completed warranty registration card for the tool, and then submits proof of ownership and an acceptable statement describing such Act of God documented by an insurance carrier, police department, or other official governmental source. To obtain instructions for filing a claim call 1-800-543-4596.

CUSTOMER SATISFACTION

One hundred percent customer satisfaction is our #1 goal. If for any reason the product does not perform to the original purchaser's satisfaction, it can be returned to the place of purchase **within thirty days** with dated sales receipt for a full refund of the purchase price.

© 2006 by SENCO PRODUCTS, INC.

CINCINNATI, OHIO 45244-1611 USA

www.senco.com

070101